

BSW110 Technical Data Sheet



BSW110 Series Pedestal Supports are used to make raised floors at varying heights from 82 mm up to 658 mm and more. Used in joist framing and installations with decking or composite flooring materials.

BSW110 Product Features

Raw Material	Polypropylene
Height Range	Min. 82 mm - Max. 658 mm
Base Diameter	187 mm
Base Wall Thickness	3 mm
Head Diameter	138 mm
Laying Surface of the Base	302 cm ²
Slope Correction	% 0
Environmental Impact Assessment	Eco - Friendly
Application Areas	Can be used for all indoor and outdoor areas. Also, on levelled surfaces, epoxy or membrane insulated in areas.
Application	Using any of fixing material is not necessary. Optionally, the modules can be fixed to the application surface using adhesive or screw.
Width of the floor joist (d)	Min. 45 mm - Max. 85 mm (Adjustable)

BSW110 Technical Drawing

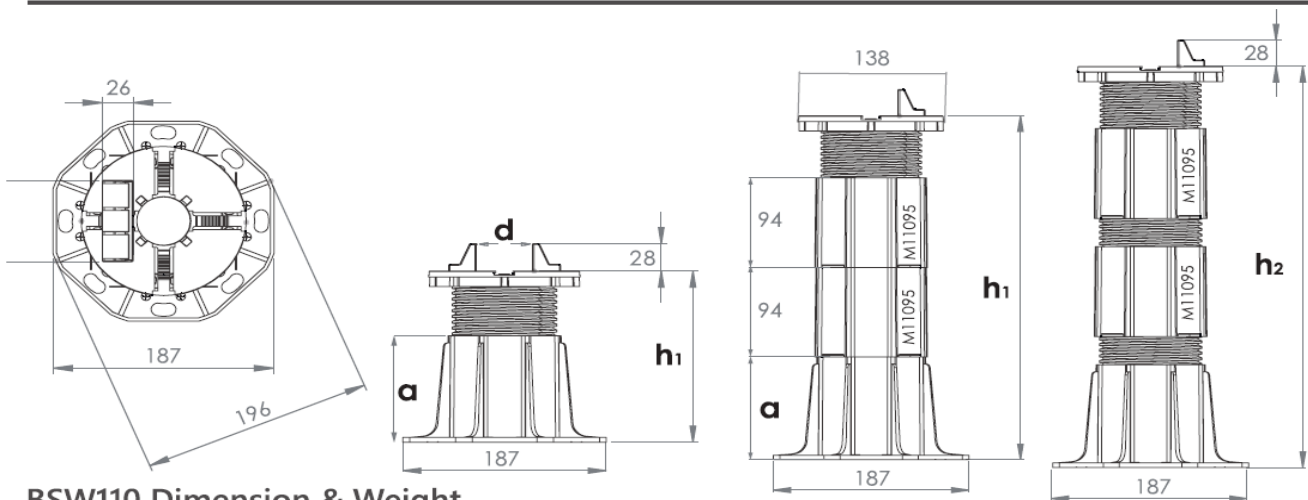

BSW110 Dimension & Weight

Model	BSW110-04	BSW110-05	BSW110-06	BSW110-07	BSW110-08	BSW110-09	BSW110-10	BSW110-11	BSW110-12	BSW110-13
a	65 mm	109 mm	65 mm	109 mm	65 mm	109 mm	65 mm	109 mm	65 mm	109 mm
h1 (min.- max)	82-131 mm	125-175 mm	175-224 mm	219-270 mm	270-319 mm	313-362 mm	363-413 mm	407-455 mm	456-506 mm	500-550 mm
h2	-	-	250 mm	295 mm	372 mm	417 mm	493 mm	538 mm	613 mm	658 mm
Extension	-	-	M11095	M11095	M11095	M11095	M11095	M11095	M11095	M11095
Weight	0,343 gr	0,415 gr	-	-	-	-	-	-	-	-
Comp.			x1	x1	x2	x2	x3	x3	x4	x4

BSW110 Pressure Resistance

Pressure measuring point

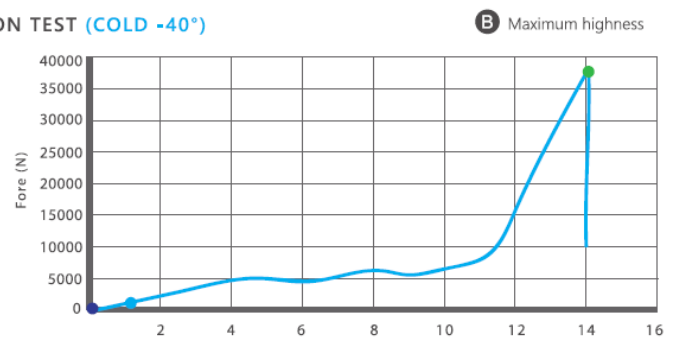
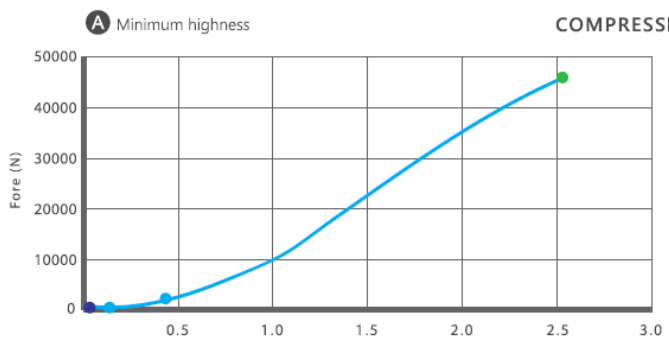
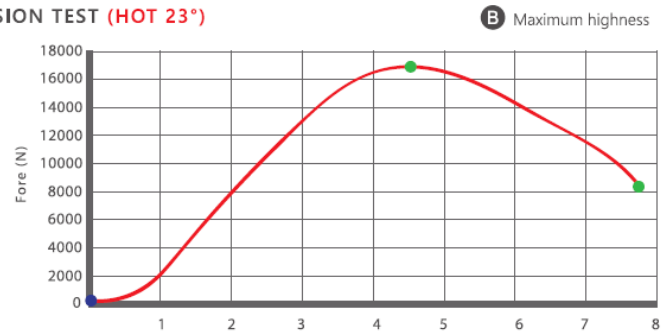
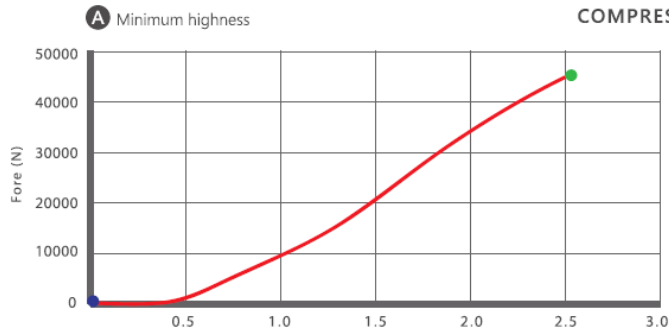
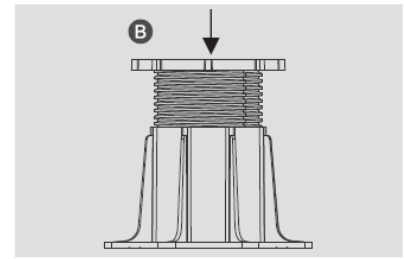
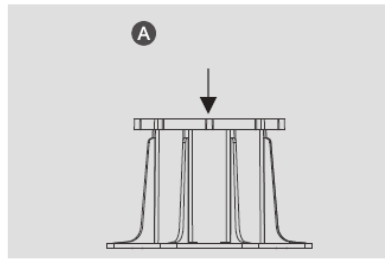

TESTED AND APPROVED BY HEADSHIP OF TURKISH STANDARDS INSTITUTION (TSE) AND CALIBRATION CENTER CONSTRUCTION MATERIALS LABORATORY (ANKARA CITY)

BSW110 Packaging Information

Product code	BSW110-04	BSW110-05	BSW110-06	BSW110-07	M11095
Pcs per box	24*	20*	16*	14*	24**
Gross weight per box	10,50 kg	10,00 kg	10,70 kg	10,25 kg	5,40 kg
Boxes per pallet	12	12	12	12	24
Box dimensions	60cm x 40cm [*] x h=40cm	40cm x 30cm ^{**} x h=41cm	40cm x 30cm ^{***} x h=20cm		
Gross weight per pallet	151 kg	145 kg	153 kg	148 kg	155 kg
Pallet dimensions	cm 80 x 120 x h140				

* Products are packed in cardboard boxes. Shrink-wrapped euro-pallets are used for final packaging. In spite of being shrink-wrapped and rain proof packagings, recommended to keep the pallets in closed area.

