

ES70 Technical Data Sheet



ES70 Series, Modules are suitable to create raised floors from tiles and pavers. In compliance with this type of flooring can be used with natural stone, ceramic and composite materials.

ES70 Product Features



Height Range	Adjustable min. 45mm – max. 520 mm (Optionally, extra 'extension' can be used to increase the height more than 280mm)
Base Diameter	165 mm
Base Thickness	3 mm
Head Diameter	130 mm
Laying Surface of the Base	204.56 cm ² Octagonal surface (Short edge materials provide an advantage in installation)
Tab Thickness	2 mm / 3 mm / 4 mm (Can be changed as per request)
Tab Height	10 mm
Lock system	Pin lock system
Environmental Impact Assessment	Eco - Friendly
Application Areas	Can be used for all indoor and outdoor areas. Also, on levelled surfaces, epoxy or membrane insulated in areas.
Application	Using any of fixing material is not necessary. Optionally, the modules can be fixed to the application surface using adhesive or screw.

ES70 Technical Drawing

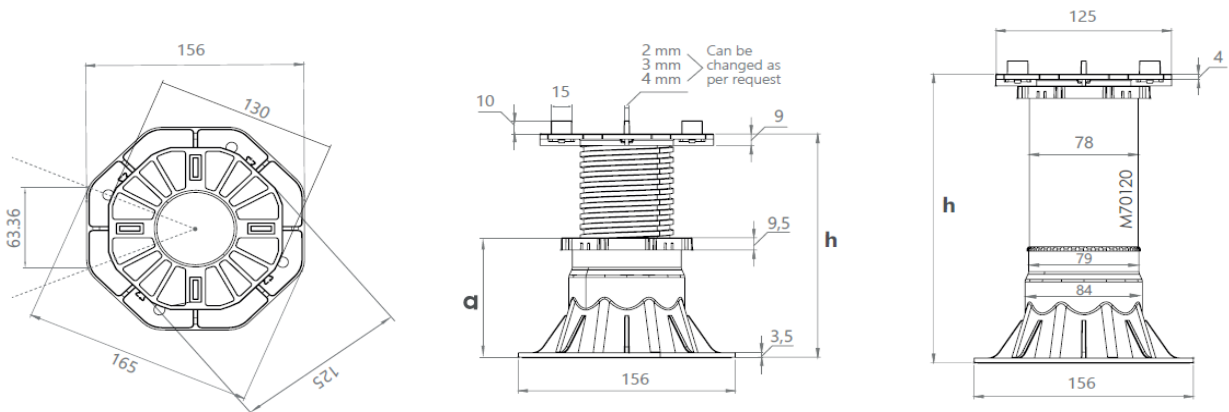

	ES70-02	ES70-03	ES70-04	ES70-05	ES70-06	ES70-06
a	36 mm	56 mm	92 mm	151 mm	151 mm	151 mm
h (min. - max)	45-65 mm	65-100 mm	100-160 mm	160-280 mm	280-400 mm	400-520 mm
Extension	-	-	-	-	M70120	M70120
Weight	195 gr	235 gr	305 gr	425 gr	511 gr	597 gr
Comp.						

ES70 Raw Material Information

Carrier	Polypropylene
Product Code	240 KTPH
Product Colour	Black
Filler	Calcium Carbonate (CaCO ₃)

Test	Testing conditions	Temperature	Standard
VICAT softening temperature , /A	10 N	min. 150 °C	9-DT-0055(ISO 306)
VICAT softening temperature , /B	50 N	min. 95 °C	9-DT-0055(ISO 306)
Bending temperature under heat, HDT, /A	1.8 Mpa	min. 63 °C	9-DT-0054(ISO 75)
Bending temperature under heat, HDT, /B	0.45 Mpa	min. 117 °C	9-DT-0054(ISO 75)

ES70 Pressure Resistance

Pressure measuring point

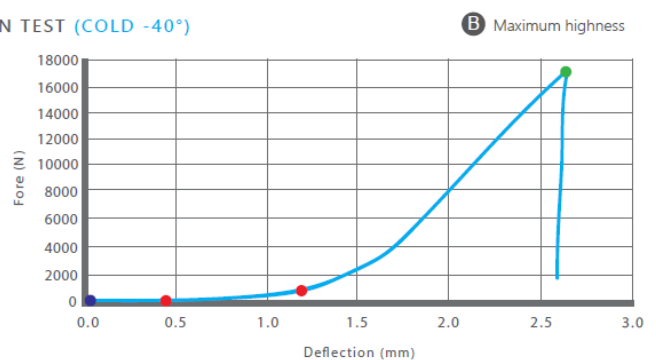
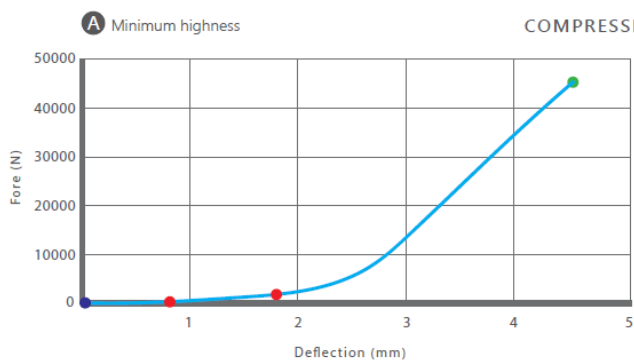
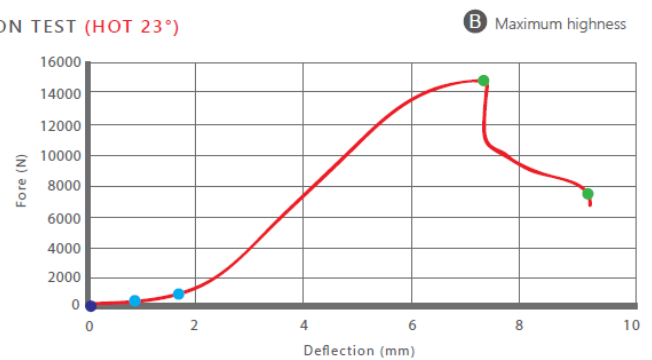
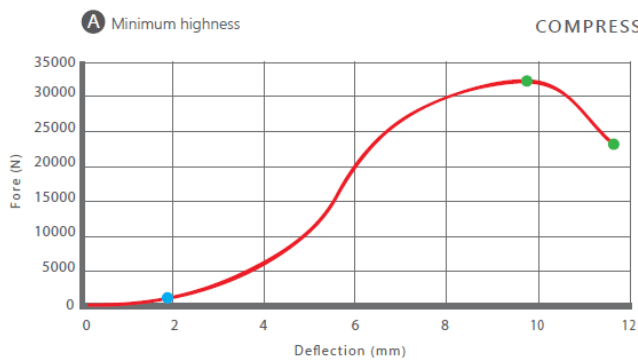
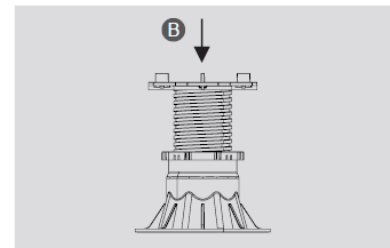
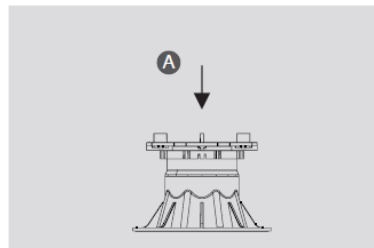

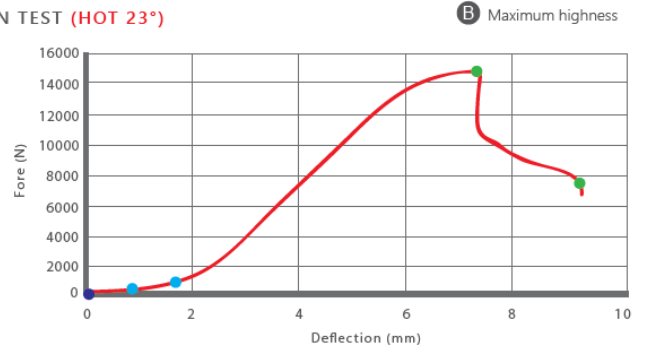
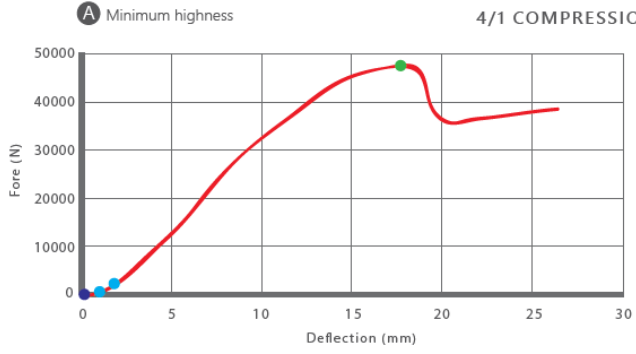
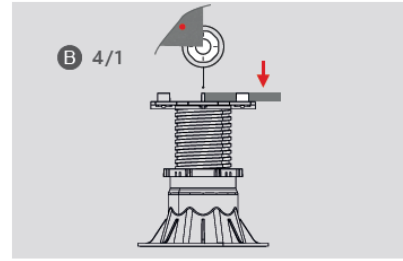
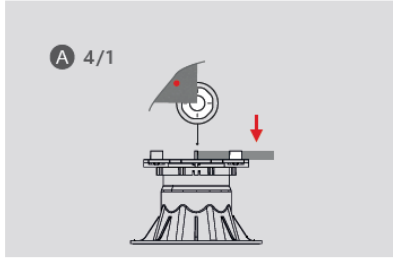

TESTED AND APPROVED BY HEADSHIP OF TURKISH STANDARDS INSTITUTION (TSE) AND CALIBRATION CENTER CONSTRUCTION MATERIALS LABORATORY (ANKARA CITY)

ES70 Packaging Information

Product code	ES70-02	ES70-03	ES70-04	ES70-05	ES70-06	ES70-07
Qty. per pack	32 pcs.	32 pcs.	16 pcs.	16 pcs.		
Pack weight	6.40 kg	7.70 kg	5.00 kg	7.00 kg		
Number of packs per pallet	72 pack	48 pack	72 pack	48 pack		
Pallet dimension	1000 mm x 1200 mm					
Pallet weight (Kg)	480 kg	390 kg	379 kg	355 kg		
Qty. per 40ft container	48.384 pcs.	32.256 pcs.	24.192 pcs.	16.128 pcs.		

* Products are packed in cardboard boxes. Shrink-wrapped euro-pallets are used for final packaging. In spite of being shrink-wrapped and rain proof packagings, recommended to keep the pallets in closed area.

* The technical data products above indicate the current production. It may be updated or modified at any time without prior notice by Öztürk Plastik Kalıp San. Tic. Ltd. Şti.

* We do not take any responsibility for any problem which caused misuse of the products.



ES70
SERIES

