

SL110 Technical Data Sheet



SL110 Series Pedestal Supports designed to construct raised floors at varying heights from 85mm up to 660mm and more. Used in tiling/paving applications with natural stone, ceramic and composite flooring materials. Thanks to 'self levelling modul', SL110 Series Supports, allow auto correction on sloped surfaces maximum up to 5% gradient.

SL110 Product Features

Raw Material	Polypropylene
Height Range	Min. 85 mm - Max. 660 mm
Base Diameter	187 mm
Base Wall Thickness	3 mm
Head Diameter	126 mm
Laying Surface of the Base	302 cm ²
Tab Thickness	2 mm / 3 mm / 4 mm (removable)
Tab Height	10 mm
Slope Correction	% 5
Environmental Impact Assessment	Eco - Friendly
Application Areas	Can be used for all indoor and outdoor areas. Also, on levelled surfaces, epoxy or membrane insulated in areas.
Application	Using any of fixing material is not necessary. Optionally, the modules can be fixed to the application surface using adhesive or screw.

SL110 Technical Drawing

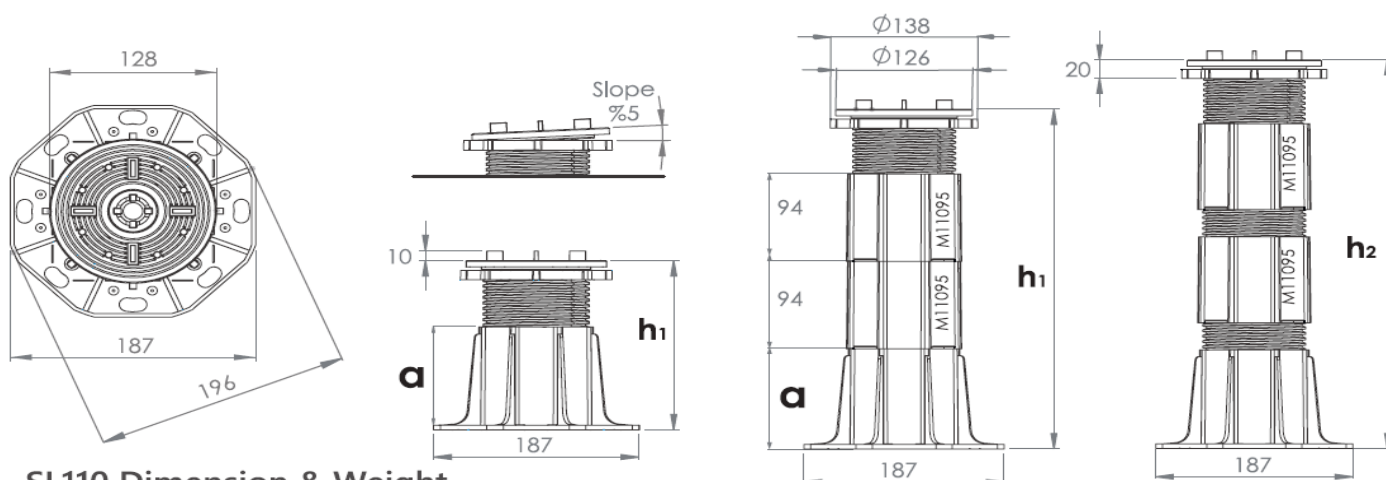

SL110 Dimension & Weight

Model	SL110-04	SL110-05	SL110-06	SL110-07	SL110-08	SL110-09	SL110-10	SL110-11	SL110-12	SL110-13
a	65 mm	109 mm	65 mm	109 mm	65 mm	109 mm	65 mm	109 mm	65 mm	109 mm
h1 (min.- max)	85-135 mm	130-180 mm	180-228 mm	224-272 mm	273-322 mm	317-366 mm	367-415 mm	410-460 mm	460-510 mm	505-553 mm
h2	-	-	255 mm	300 mm	377 mm	420 mm	497 mm	540 mm	617 mm	660 mm
Extension	-	-	M11095	M11095	M11095	M11095	M11095	M11095	M11095	M11095
Weight	0,409 gr	0,481 gr	-	-	-	-	-	-	-	-
Comp.			x1	x1	x2	x2	x3	x3	x4	x4

SL110 Pressure Resistance

Pressure measuring point

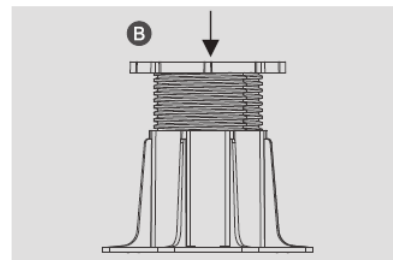
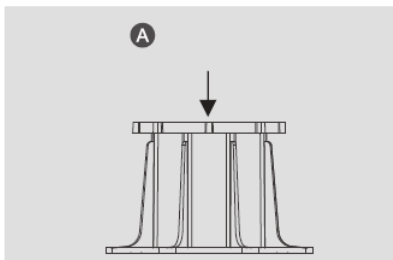

A Minimum highness

COMPRESSION TEST (HOT 23°)

B Maximum highness

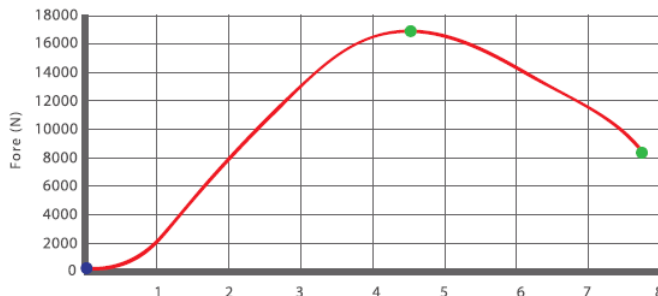
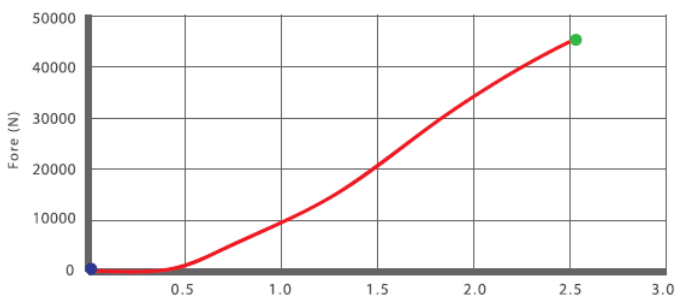

A Minimum highness

COMPRESSION TEST (COLD -40°)

B Maximum highness

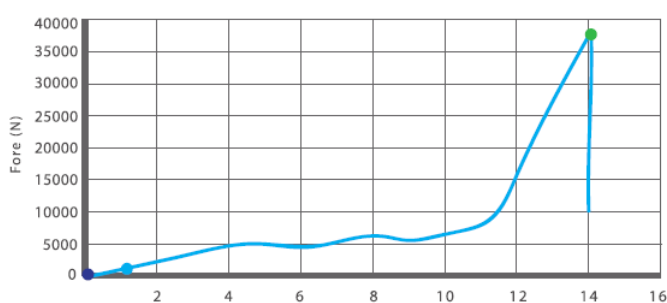
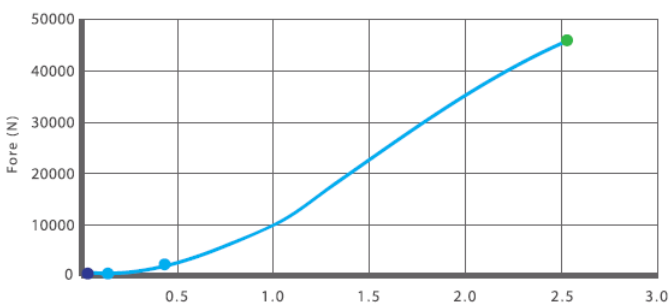

TESTED AND APPROVED BY HEADSHIP OF TURKISH STANDARDS INSTITUTION (TSE) AND CALIBRATION CENTER CONSTRUCTION MATERIALS LABORATORY (ANKARA CITY)

SL110 Packaging Information

Product code	SL110-04	SL110-05	SL110-06	SL110-07	M11095
Pcs per box	24*	20*	16*	14*	24**
Gross weight per box	11,25 kg	10,65 kg	11,15 kg	10,70 kg	5,40 kg
Boxes per pallet	12	12	12	12	24
Box dimensions	* 60cm x 40cm x h=40cm		** 40cm x 30cm x h=41cm	*** 40cm x 30cm x h=20cm	
Gross weight per pallet	160 kg	153 kg	159 kg	153 kg	155 kg
Pallet dimensions	cm 80 x 120 x h140				

* Products are packed in cardboard boxes. Shrink-wrapped euro-pallets are used for final packaging. In spite of being shrink-wrapped and rain proof packagings, recommended to keep the pallets in closed area.

